



TPD-433-M2

4.3" Touch HMI Device with 1x RS-485, 1 x RS-232, Ethernet (PoE)



TPD-432F-H

4.3" Touch HMI Device with 2 x RS-485



TPD-433F-H

4.3" Touch HMI Device with 1 x RS-485, 1 x RS-232, Ethernet (PoE)

Features

- High-color high-resolution touch screen
- PoE (Power over Ethernet) for TPD-433 Series
- RS-485 (including Self-Tuner)
- RTC (Real Time Clock)
- Buzzer
- Free HMIWorks development tool
- Support C language and Ladder Designer
- Modbus TCP/RTU & DCON protocols
- Support user-defined third party protocol (C language)
- Operating Temperature: -20 ~ 50 °C



Introduction

The **TouchPAD TPD 4.3" Series**, TPD-432F-H/TPD-433F-H/TPD-433-M2, is a series of touch HMI and designed for building and home automation. The TPD 4.3" Series is equipped with high-color high-resolution TFT touch screen and fits in with regular electrical wall-mount outlet. Besides, it is seamlessly integrated with rich I/O modules and presents beautiful, flexible and user-defined picture frame. In short, it is the best choice to upgrade the mechanical switch to intelligent control pads.

For PLC users, HMIWorks provides Ladder Designer, and for IT users, C language environment is provided. Especially, it only takes no more than 30 minutes to learn how to create an application program of TouchPAD series devices when using Ladder Designer. Moreover, by utilizing the Ethernet functionality of the TouchPAD, users can easily implement a redundant control solutions. With all the features provided, TouchPAD series touch HMI Devices must be the most cost effective HMI Device ever been in the market.

Applications

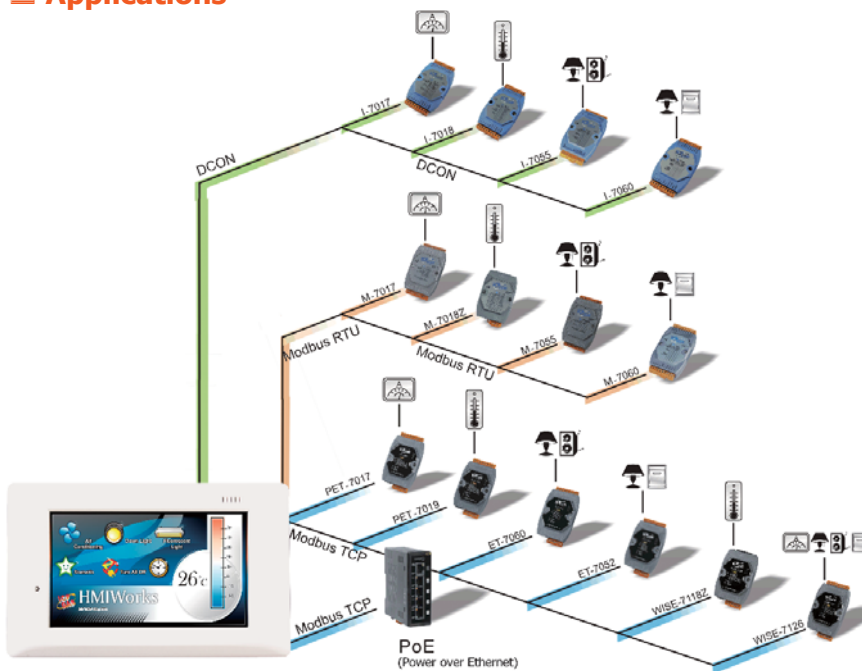

TPD-433F-H with External Wall Box EWB-T43F2



TPD-433F-H with Outlet Box OB140F

The space between the Ethernet plug and the bottom of the external wall box is too small to bend the coated Ethernet plug

Specifications

Model	TPD-432F-H	TPD-433F-H	TPD-433-M2
Main Unit			
CPU	32-bit RISC CPU		
Storage	16 MB SDRAM/16 MB Flash		
Real Time Clock	Yes		
Display			
Type	LCD 4.3" TFT (Resolution 480 X 272 X 16), defective pixels <= 3		
Backlight Life	20,000 hours		
Brightness	400 cd/m2		
Touch Panel	Yes		
COM Ports			
Ports	2 x RS-485 (including Self-Tuner)	1 x RS-485 (including Self-Tuner) 1 x RS-232 (3-pin)	1 x RS-485 (including Self-Tuner) 1 x RS-232 (3-pin)
HMI			
Buzzer	Yes		
Rotary Switch	Yes		
Reset Button	Yes		
Ethernet			
Ports	RJ-45 x 1, 10/100 Base-TX		
Power			
Consumption	2.5 W		
Powered from PoE	IEEE 802.3af, Class1 (48 V)		
Powered from Terminal Block	+12 ~ 48 VDC		
Mechanical			
Dimensions (mm)	140 mm x 87 mm x 41 mm	140 mm x 87 mm x 41 mm	140 mm x 98 mm x 30 mm
Installation	Wall Mounting		
Ingress Protection Rating	Front Panel: IP40		
Environmental			
Operating Temperature	-30 ~ +50°C		
Storage Temperature	-30 ~ +80 °C		
Humidity	10 ~ 90% RH, Non-condensing		

Pin Assignments

TPD-432F-H

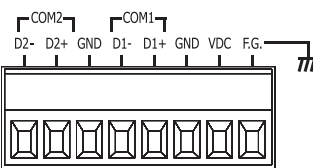

TPD-433F-H/433-M2

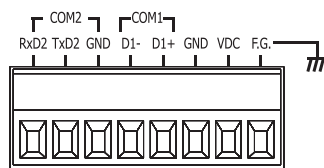

Appearance

Front View



TPD-432F-H Rear View

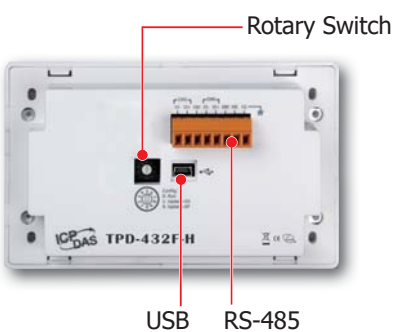

TPD-433F-H Rear View

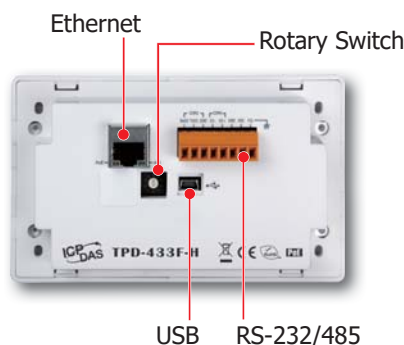

TPD-433-M2 Rear View

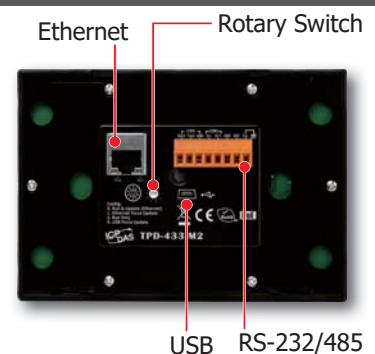

Dimensions (Units: mm)

TPD-433-M2

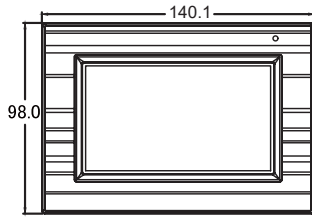

Front View

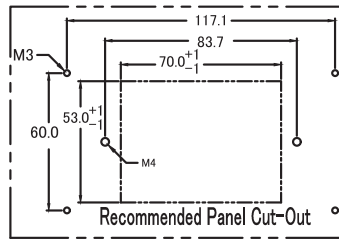

Wall Mounting

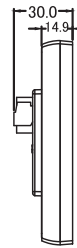

Left View

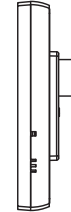

Right View

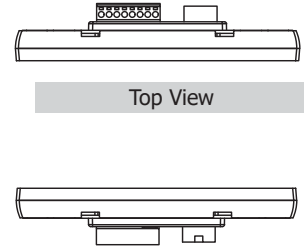

Top View

Bottom View

TPD-433F-H

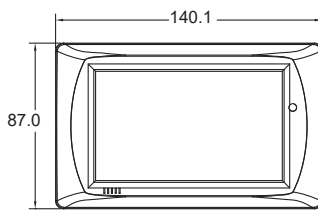

Front View

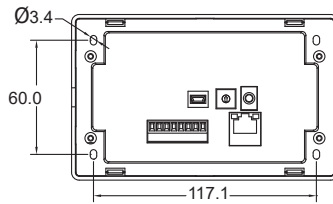

Rear View

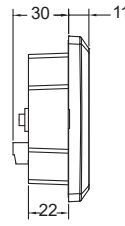

Left View



Right View

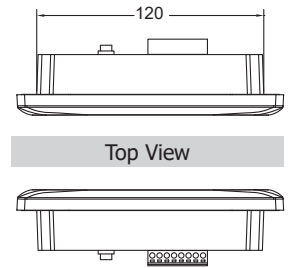

Top View

Bottom View

TPD-432F-H

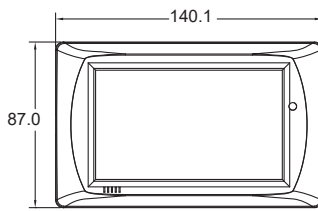

Front View

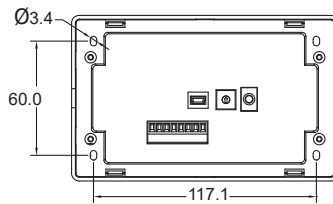

Rear View

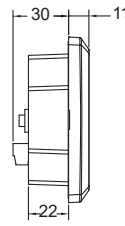

Left View

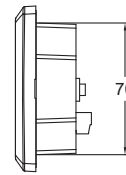

Right View

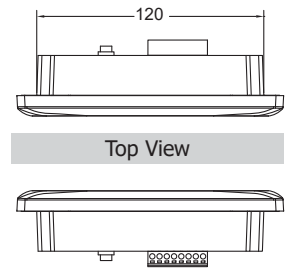

Top View

Bottom View

Ordering Information

TPD-432F-H CR	4.3" Touch HMI Device with 2 x RS-485, RTC and USB Download Port (RoHS)
TPD-433F-H CR	4.3" Touch HMI Device with 1 x RS-485, 1 x RS-232, Ethernet (PoE), RTC and USB Download Port (RoHS)
TPD-433-M2 CR	4.3" Touch HMI Device with 1x RS-485, 1 x RS-232, Ethernet (PoE), RTC and USB Download Port (Grey) (RoHS)

Accessories

CA-USB10	USB to 5P Mini-USB, 28AWG, 1.5 m	EWB-T43F2	External Wall Box for TPD-432F-H/TPD-433F-H/TPD-433-M2
NS-208PSE CR	Unmanaged Industrial PoE (Power over Ethernet) Ethernet Switch (RoHS)	OB140F	Outlet Box for TPD-432F-H/TPD-433F-H/TPD-433-M2
MDR-60-24 CR	24 VDC/2.5 A, 60 W Power Supply with DIN-Rail Mounting (RoHS)	OB140FP	Plastic outlet Box for TPD-432F-H/TPD-433F-H/TPD-433-M2