



- DL-301-WF-IP65**
- DL-302-WF-IP65**
- DL-303-WF-IP65**
- DL-304-WF-IP65**
- DL-305-WF-IP43**
- DL-306-WF-IP65**
- DL-307-WF-IP65**
- DL-308-WF-IP65**

Remote CO/CO2/HCHO/TVOC/NH3/H2S/Temperature/Humidity/Dew Point Data Logger Module (Asia Only)

### Introduction

The DL-300-WF-IP65 series is a gas detector monitoring module with Wi-Fi, Ethernet and RS-485 interfaces. It provides a WLAN connection which complies with the IEEE802.11b/g/n standards. With the popularity of 802.11 network infrastructure, the modules make an easy way to incorporate wireless connectivity into monitoring and control systems. The DL-300-WF-IP65 series of Data Logger devices can be used to record CO, CO2, HCHO, TVOC, NH3, H2S, Temperature, Humidity and Dew Point information, including date and time stamps, and are able to store up to 450,000 downloadable records. Real-time data can be accessed from the DL-300-WF-IP65 series Data Logger from anywhere and at any time using the free Windows software, the iOS App or the Android App, as long as they are connected to the same local network as the data Logger. Support is provided for popular industrial protocols such as DCON, Modbus RTU, and Modbus TCP. For Ethernet interface, It also support the emerging machine-to-machine (M2M)/IoT (Internet of Things) connectivity protocol - MQTT. The DL-300-WF-IP65 series Data Logger can be connected via widely used communication interfaces including RS-485, Ethernet, PoE and Wi-Fi, meaning that the device can be easily integrated into existing HMI or SCADA systems, and is easy to be maintained in a distributed control system. The IP65/IP43 version of DL-300-WF-IP65 series is designed for industrial applications in harsh environments that provides IP65 grade protection approval. The rugged RJ-45 ensures tight, robust connections, and guarantees reliable operation, even for applications that are subject to high vibration and shock.

#### Large 2.8" LCD Touch Screen, with clear Color Chart to indicate the CO/CO2 Level

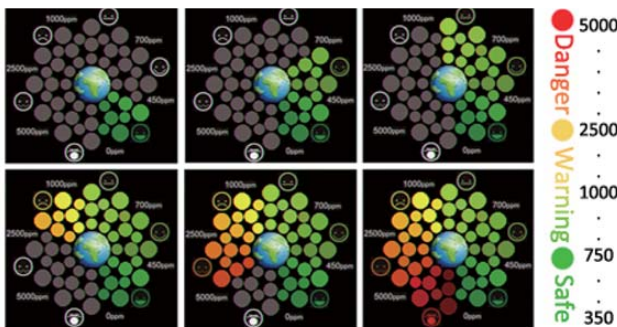

#### Simple and powerful utility

The DL300 Utility can be used to configure the modules, monitor real-time data, group DL-300 modules so that the status of distribution groups can be viewed and managed. The utility also allows the log data to be downloaded and exported to a .CSV file that can then be imported into any industry-standard software or spread sheet for analysis.

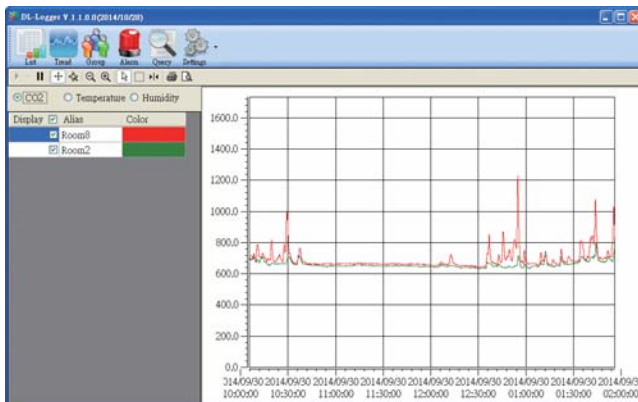

### Features

- Able to record CO, CO2, HCHO, TVOC, NH3, H2S, Temperature, Humidity, and Dew Point Measurements
- Non-dispersive Infrared (NDIR) CO2 Sensor
- 2.8" LCD Touch Screen
- Up to 450,000 Records with Date and Time Stamps
- Touch-screen and Web-based Configuration Interface
- Simple and Powerful Software Utility, iOS App and Android App Included
- Able to Display Multilingual Messages on the Screen
- Supports the DCON, Modbus RTU and Modbus TCP Protocols
- Supports the MQTT Protocol for Ethernet Interface
- Includes RS-485/Ethernet/Wi-Fi Communication Interfaces
- Includes Redundant Power Inputs: PoE (IEEE 802.3af, Class 1) and DC Input
- Compatible with IEEE802.11b/g/n Standards
- Support Infrastructure and Limit-AP Modes for Wireless Networks
- Relay Output for Audible/Visual Alarm or Device Control
- Web-based configuration interface and firmware update via Ethernet
- IP65/IP43 Protection Approval



#### Supports the MQTT Protocol for IoT Applications

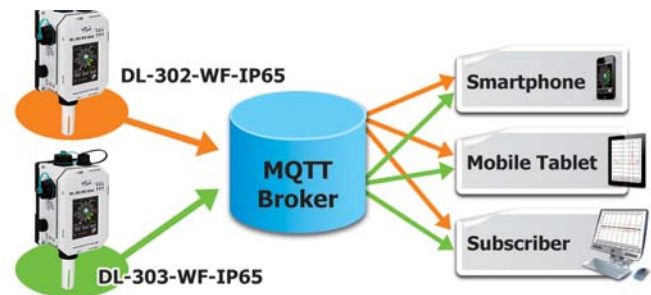

#### Multi-platform Remote Access Software

Real-time data from the DL-300 Data Logger can be accessed from anywhere and at any time using the DL300 Utility, the iOS or Android App, or via a regular web browser, as long as they are connected to the same local network as the Data Logger.



#### Display Messages in Multiple Languages

The display-message-on-screen function supports multiple language character sets based on UTF-8 encoding. Either pre-configured messages or dynamic messages can be remotely displayed using Modbus commands, or a dynamic message can be sent via the web-based interface.



➤ Real-time data from the DL-300-WF series can be accessed from anywhere and at any time using the WF-IIOT-Utility and iOS App.



▲ iOS APP QR CODE



▲ Android APP QR CODE

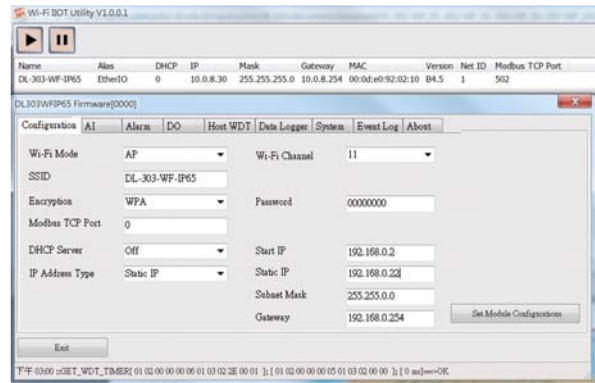

▲ WiFi\_IIOT\_UTILITY

### Appearance

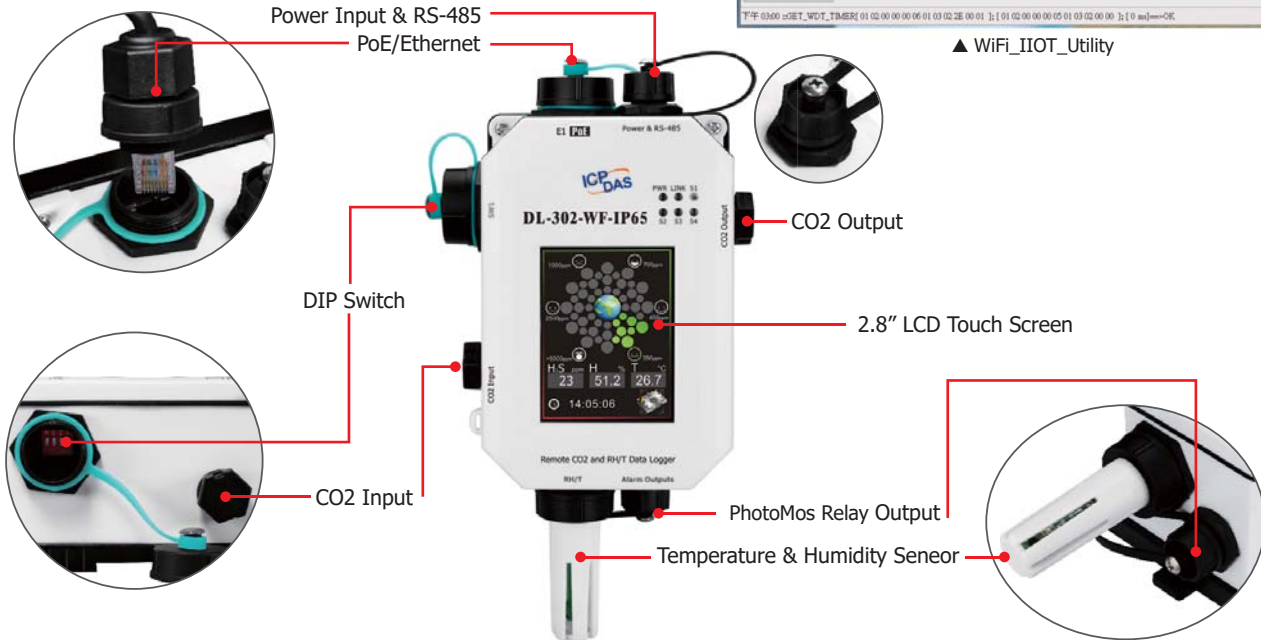

### Dimensions (Units: mm)

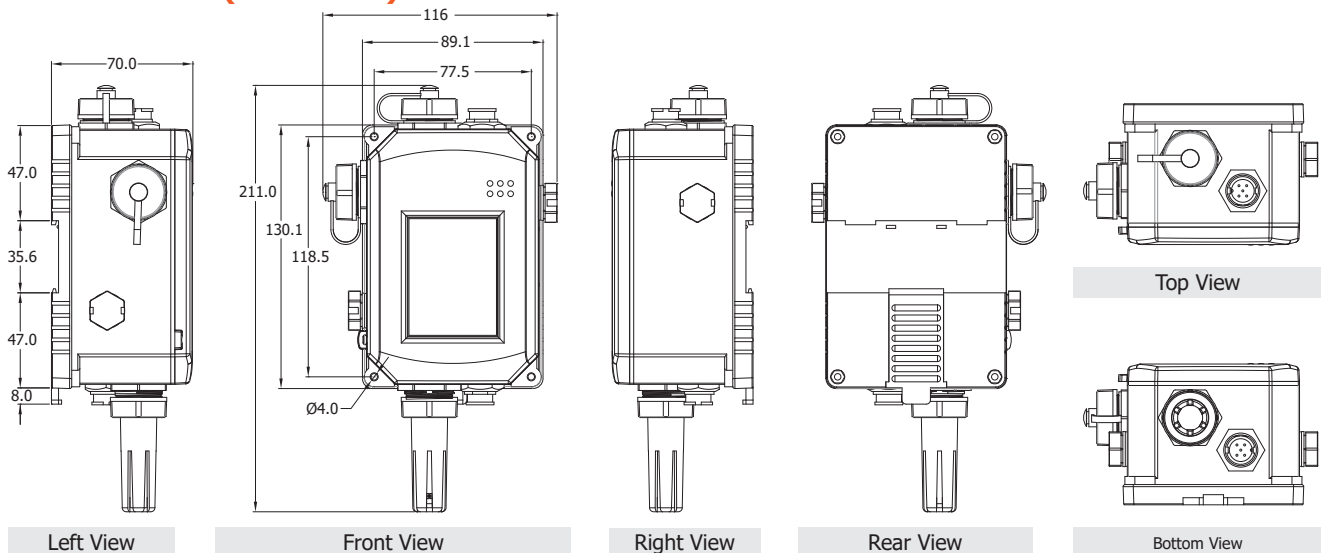

#### IP65 Ethernet Cap with Tether

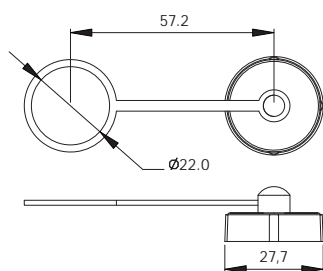

#### IP65 Ethernet Plug

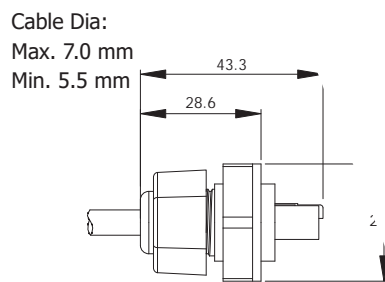

#### IP65 PWR Plug

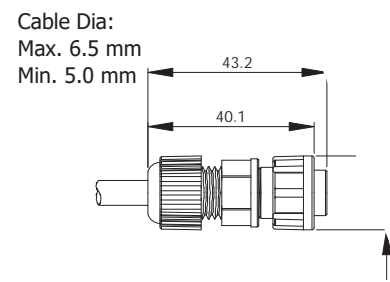



## Applications

### Mushroom Farm

Mushroom growth yield requires long time to monitor the environment of CO2 concentration, temperature and humidity values, and its growth environment is high humidity condition. The general equipment cannot work in such environment, but the DL-302-WF-IP65 can be used to record CO2, temperature, humidity and dew point information with date and time stamps in the operating temperature from -20°C to +50°C, and are able to store up to 450,000 downloadable records . The WISE-5231-3GWA features timer and schedule functions. It allows user to schedule specific date or time for control logic execution, or perform specific tasks such as time delay. With calendar user interface provided, schedule setting can be more efficient and flexible. This does not require programming, only some simple settings will be able to achieve the farm production control and quality control, production resume ... and so on.



### Pig Farm

Ammonia and Hydrogen sulfide are two of the most harmful gases in animal farming environment. They will directly affect animals' growth and immunity. Pig farm requires long-term immediate monitoring the environment of NH3 concentration, temperature and humidity values. The general equipment cannot work in such environment, but the DL-305-WF-IP65 can be used to record NH3, temperature, humidity and dew point information with date and time stamps in the operating temperature from -20°C to +50°C, and are able to store up to 450,000 downloadable records . The WISE-5231-3GWA features timer and schedule functions. It allows user to schedule specific date or time for control logic execution, or perform specific tasks such as time delay. With calendar user interface provided, schedule setting can be more efficient and flexible. This does not require programming, only some simple settings will be able to achieve the farm production control and quality control, production resume ... and so on.



## System Specifications

Model	DL-301-WF-IP65	DL-302-WF-IP65	DL-303-WF-IP65	DL-304-WF-IP65	DL-305-WF-IP43	DL-306-WF-IP65	DL-307-WF-IP65	DL-308-WF-IP65	
<b>System</b>									
CO Alarm	Yes	-	Yes			-			
CO2 Alarm		Yes	Yes			-			
HCHO Alarm		-		Yes		-	Yes	-	
TVOC Alarm		-		Yes		-		Yes	
NH3 Alarm			-		Yes		-		
H2S Alarm			-			Yes		-	
RH/Temperature Alarm				Yes					
Real Time Clock				Yes					
Data Logger				Yes, up to 450,000 records					
Relay Output				PhotoMos Relay × 4, 100 VDC @ 1 A					
<b>Software</b>									
Built-in Web Server				Yes					
<b>CPU Module</b>									
Real Time Clock				Yes					
Watchdog Timer				Yes, Module (2.3 sec), Communication (Programmable)					
<b>Display</b>									
Backlight Life				20,000 hours					
Brightness				160 cd/m2					
Touch Panel				Yes					
LCD Information Displayed				2.8 TFT (Resolution 240 x 320 x 16), Defective Pixels <= 3					
<b>LED Indicators</b>									
	PWR			Green for normal operation					
Status	Link			Green for the Ethernet-linked					
	S1 ~ S4			Red for an alarm condition					
<b>System</b>									
Security				IP filter (whitelist) and Password (web)					
Real Time Clock				Yes					
Security				Yes, up to 450,000 records					
<b>Wi-Fi</b>									
Transmission Range				50 meters (LOS)					
Standard Supported				IEEE 802.11 b/g/n					
RX Sensitivity				-95.7 dBm @ 1 DSSS, -74.0 dBm @ 54 OFDM					
Output Power				18 dBm @ 1 DSSS, 14.5 dBm @ 54 OFDM					
Mode				Infrastructure & Limited AP					
Protocol				Modbus/TCP					
Encryption				WEP, WPA and WPA2					
Antenna				1 dBi (PCB Antenna)					
<b>Relay Output</b>									
Type				PhotoMos Relay × 4, 100 VDC @ 1 A					
<b>COM Ports</b>									
Ports				1 x RS-485					
Baud Rate				1200 ~ 115200 bps					
Protocol				DCON, Modbus/RTU					
<b>Ethernet</b>									
Ports				10/100 Base-TX, 8-Pin RJ-45 x1(Auto-negotiating, Auto-MDI/MDIX, LED indicators)					
PoE				Yes					
Protocol				Modbus/TCP, MQTT					
<b>Power</b>									
Consumption	PoE	3.4 W (Max.)	3.5 W (Max.)	3.5 W (Max.)	2.0 W (Max.)	2.9 W (Max.)	2.9 W (Max.)	2.1 W (Max.)	2.0 W (Max.)
	Non-PoE	3.1 W (Max.)	3.1 W (Max.)	3.2 W (Max.)	2.0 W (Max.)	3.0 W (Max.)	3.0 W (Max.)	2.1 W (Max.)	2.0 W (Max.)
Powered from PoE				+12 ~+48 VDC					
Powered from Terminal Block				IEEE 802.3af, Class 1 (48 V)					
<b>Mechanical</b>									
Dimensions (mm)				116 x 211 x 70 (W x L x H)					
Installation				DIN-Rail or Wall Mounting					
Ingress Protection Rating			IP65		IP43			IP65	
<b>Environment</b>									
Operating Temperature				-20 to +50°C					
Storage Temperature				-30 to +75°C					
Humidity				10 ~ 90% RH, Non-condensing					



## I/O Specifications

Model	DL-301-WF-IP65	DL-302-WF-IP65	DL-303-WF-IP65	DL-304-WF-IP65	DL-305-WF-IP43	DL-306-WF-IP65	DL-307-WF-IP65	DL-308-WF-IP65
<b>CO Measurement</b>								
Range	0 to 1000 ppm (Electrochemical)	-	0 to 1000 ppm (Electrochemical)			-		
Resolution	1 ppm	-	1 ppm			-		
Accuracy	±5% of measured value	-	±5% of measured value			-		
Response Time	30 sec	-	30 sec			-		
Warm-up Time	300 sec	-	300 sec			-		
<b>CO2 Measurement</b>								
Range	-	0 to 9999 ppm (NDIR)				-		
Resolution	-	1 ppm				-		
Accuracy	-	±30 ppm ±3% of measured value				-		
Response Time	-	20 sec				-		
Warm-up Time	-	60 sec				-		
<b>HCHO Measurement</b>								
Range		-		0 ppb to 2000 ppb (Electrochemical)		-	0 ppb to 2000 ppb (Electrochemical)	-
Resolution		-		1 ppb		-	1 ppb	-
Accuracy		-		0 ~ 300ppb : ±30ppb > 300ppb : ±10%		-	0 ~ 300ppb : ±30ppb > 300ppb : ±10%	-
Response Time		-		≤60 sec		-	≤60 sec	-
Warm-up Time		-		180 sec		-	180 sec	-
<b>TVOC Measurement</b>								
Range		-		0 ppb to 60000 ppb (MEMS Metal Oxide)		-		0 ppb to 60000 ppb (MEMS Metal Oxide)
Resolution		-		1 ppb		-		1 ppb
Accuracy		-		±15%		-		±15%
Response Time		-		60 sec		-		60 sec
Warm-up Time		-		180 sec		-		180 sec
<b>NH3 Measurement</b>								
Range		-			0 to 100 ppm (Electrochemical)		-	
Resolution		-			1 ppm		-	
Accuracy		-			±5% of measured value		-	
Response Time		-			< 40 Sec		-	
Warm-up Time		-			60 Sec		-	
<b>H2S Measurement</b>								
Range		-				0 to 100 ppm (Electrochemical)		-
Resolution		-				1 ppm		-
Accuracy		-				±5% of measured value		-
Response Time		-				< 30 Sec		-
Warm-up Time		-				60 Sec		-
<b>Temperature Measurement</b>								
Range	-20 to +50°C							
Resolution	0.1°C							
Accuracy	±0.6°C							
<b>Relative Humidity Measurement</b>								
Range	0 to 100% RH, Non-condensing							
Resolution	0.1% RH, Non-condensing							
Accuracy	±5% RH, Non-condensing							
<b>Dew Point</b>								
Range	Calculated using temperature and relative humidity							
Resolution	0.1°C							

## Ordering Information

<b>DL-301-WF-IP65 CR</b>	IP65 Remote CO/Temperature/Humidity/Dew Point Data Logger with Safety Alarm (RS-485, Ethernet, PoE, Wi-Fi) (RoHS) (Asia Only)
<b>DL-302-WF-IP65 CR</b>	IP65 Remote CO2/Temperature/Humidity/Dew Point Data Logger with Safety Alarm (RS-485, Ethernet, PoE, Wi-Fi) (RoHS) (Asia Only)
<b>DL-303-WF-IP65 CR</b>	IP65 Remote CO/CO2/Temperature/Humidity/Dew Point Data Logger with Safety Alarm (RS-485, Ethernet, PoE, Wi-Fi) (RoHS) (Asia Only)
<b>DL-304-WF-IP65 CR</b>	IP43 Remote HCHO/TVOC/Temperature/Humidity/Dew Point Data Logger with Safety Alarm (RS-485, Ethernet, PoE, Wi-Fi) (RoHS) (Asia Only)
<b>DL-305-WF-IP43 CR</b>	IP65 Remote NH3/Temperature/Humidity/Dew Point Data Logger with Safety Alarm (RS-485, Ethernet, PoE, Wi-Fi) (RoHS) (Asia Only)
<b>DL-306-WF-IP65 CR</b>	IP65 Remote H2S/Temperature/Humidity/Dew Point Data Logger with Safety Alarm (RS-485, Ethernet, PoE, Wi-Fi) (RoHS) (Asia Only)
<b>DL-307-WF-IP65 CR</b>	IP65 Remote HCHO/Temperature/Humidity/Dew Point Data Logger with Safety Alarm (RS-485, Ethernet, PoE, Wi-Fi) (RoHS) (Asia Only)
<b>DL-308-WF-IP65 CR</b>	IP65 Remote TVOC/Temperature/Humidity/Dew Point Data Logger with Safety Alarm (RS-485, Ethernet, PoE, Wi-Fi) (RoHS) (Asia Only)

## Accessories

Mode Name	NS-205-IP67	NS-208PSE-IP67	NS-208-IP67
Picture			
PoE	–	802.3af x 8	–
Input Voltage Range	+10 VDC ~ +30 VDC (1 kV Isolated)	+46 VDC ~ +53 VDC	+12 VDC ~ +53 VDC
Installation	Wall Mounting	Wall Mounting	
Dimensions (W x L x H)(Unit: mm)	85 x 76 x 137	190 x 155 x 104	

<p>IP67 RJ-45 Plug</p>  <p>4SASO-0001</p>	<p>Cap with Tether</p>  <p>4SASO-0004</p>	<p>IP67 Waterproof Cable, 1M</p>  <p>CA-05BFFM-LL7A01</p>
--	--	--