



I-7563/I-7563U

USB to Isolated RS-485 Active Star Wiring Converter

Features

- Fully Compliant with the USB 1.1/2.0/3.0
- 3000 Vdc Isolation Protection on the RS-485 side
- ESD Protection for the RS-485 Data Line
- No External Power Supply required
- Automatic RS-485 Direction Control
- RS-485 Active Star Wiring Applications
- Transmission speed up to 921.6 kbps (For I-7563U)



Introduction

The I-7563/I-7563U is a cost-effective module for transferring serial data via USB. It allows you to connect your serial devices to systems that use a USB interface. Connecting the I-7563/I-7563U to a PC, you get one COM port on system. The I-7563/I-7563U contains "Self-Tuner", this chip auto-tunes the Baud Rate and data format to the RS-485 network. The I-7563/I-7563U module derives its power from the USB port and doesn't need any power adapter.

Do you have any RS-485 wiring problems I-7563/I-7563U is a USB to 3-channel RS-485 Hub. With RS-485 driver IC, so it can support star-shaped wiring.

Software

I-7563 Driver	Windows 98/ME/2000/XP/Vista (32/64-bit)/7 (32/64-bit)/10 (64-bit)/Linux
I-7563U Driver	Windows 98/ME/2000/XP/Vista (32/64-bit)/7 (32/64-bit)/8 (32/64-bit)/8.1 (32/64-bit)/10 (64-bit)/Linux

System Specifications

Models	I-7563	I-7563U
Interface		
USB	Fully Compliant with the USB 1.1/2.0/3.0	
RS-485	3 Channels: For active star wiring applications	
	Data1+, Data1-	
	Data2+, Data2-	
RS-485 Transmission Distance	Data3+, Data3-	
	Max. 1,200 m at 9.6 kbps; Max. 400 m at 115.2 kbps (Belden 9841 2P twisted-pair cable, if different cables are used, the transmission distance may change)	
Self-Tuner Asic Inside for RS-485	Yes	
Speed	300 ~ 115200 bps	300 ~ 921.6 kbps
Connector	RS-485	Removable 10-Pin Terminal Block
	USB	Type B
Cable Included	CA-USB18 (1.8 m Cable) x 1	
LED Indicators		
Power	Yes	
Power		
Input Voltage Range	+5 Vdc from USB	
Power Consumption	0.5 W	
Mechanical		
Casing	Plastic	
Dimensions (W x L x H)	72 mm x 35 mm x 115 mm	
Installation	DIN-Rail Mounting	
Environment		
Operating Temperature	-25 °C ~ +75 °C	
Storage Temperature	-30 °C ~ +75 °C	
Humidity	10 ~ 90% RH, non-condensing	

Applications

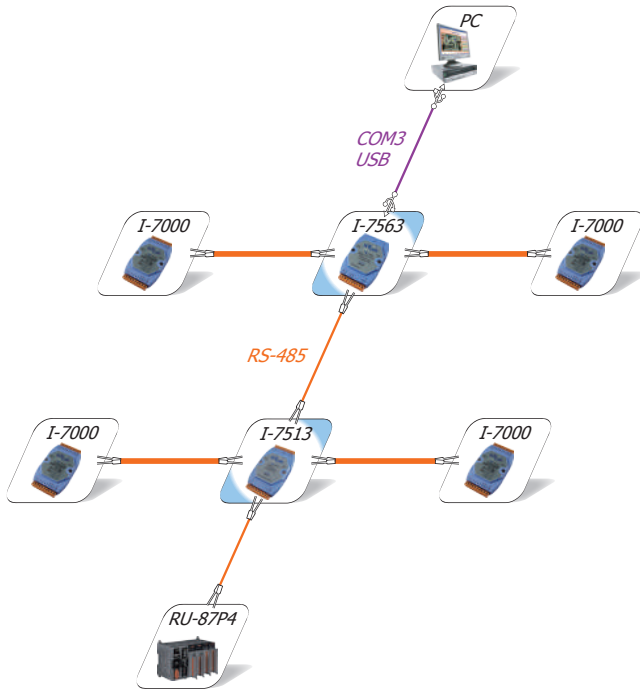

Internal I/O Structure

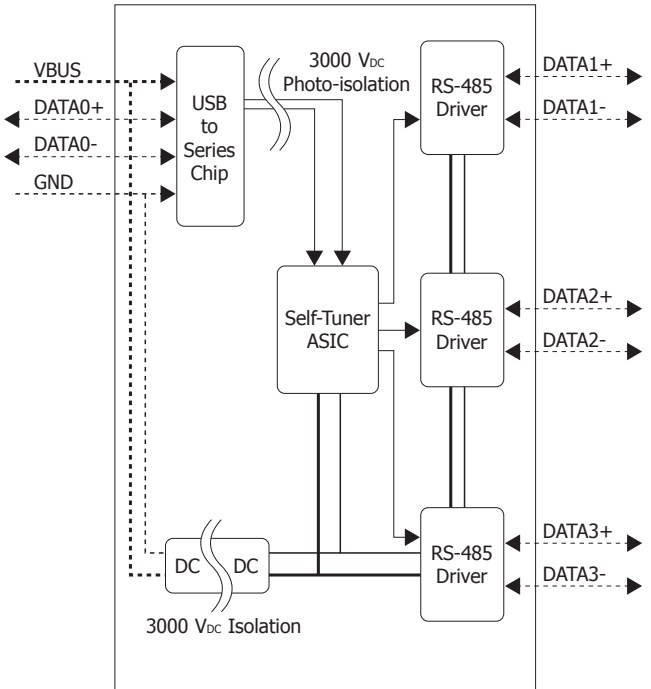

Dimensions (Units: mm)

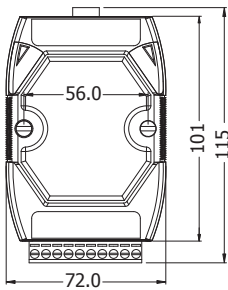

Front View

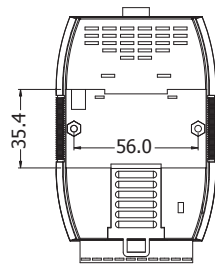

Rear View

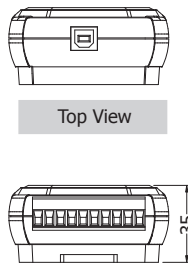

Bottom View

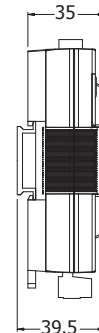

DIN-Rail Mounting Bracket

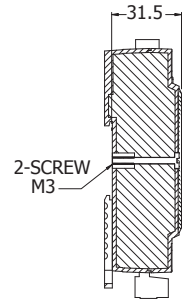

Side View

Pin Assignments



Terminal No.	Pin Assignment
RS-485	01 DATA3-
	02 DATA3+
	03 --
RS-485	04 DATA2-
	05 DATA2+
	06 --
07 --	
08 --	
RS-485	09 DATA1-
	10 DATA1+

Ordering Information

I-7563 CR	USB to Isolated RS-485 Converter with CA-USB18 Cable (Blue Cover) (RoHS)
I-7563-G CR	USB to Isolated RS-485 Converter with CA-USB18 Cable (Gray Cover) (RoHS)
I-7563U CR	High-speed USB to Isolated RS-485 Converter with CA-USB18 Cable (Gray Cover) (RoHS)

Accessories

USB-2560 CR	4-port Industrial USB 2.0 Hub (RoHS) Includes CA-USB18 Cable
-------------	---