

U97-ULTRA-2B



Model U97-ULTRA-2B

All-in-One Console Extender
Dual Video, Amplified or Line-Level Audio, RS-232, and
3 Separate USB Extensions: two Direct plus one with 4-port Hub
to 150 meters (500 ft)

UMA1158 Rev. F

**CUSTOMER
SUPPORT
INFORMATION**

Order toll-free in the U.S. 800-959-6439
FREE technical support, Call 714-641-6607 or fax 714-641-6698
Mail order: **Hall Research**, 1163 Warner Ave. Tustin, CA 92780, CA 92704
Web site: www.hallresearch.com

TRADEMARKS USED IN THIS MANUAL

Hall Research, HR, and the  logo are trademarks of Hall Research Inc. Windows™ is a trademark of Microsoft Corporation.

Any other trademarks mentioned in this manual are acknowledged to be the property of the trademark owners.

FEDERAL COMMUNICATIONS COMMISSION RADIO FREQUENCY INTERFERENCE STATEMENT

This equipment generates, uses, and can radiate radio frequency energy and if not installed and used properly, that is, in strict accordance with the manufacturer's instructions, may cause interference to radio communication. It has been designed and tested to comply with the limits for a Class A computing device in accordance with the specifications in Subpart B of Part 15 of FCC rules, which are intended to provide reasonable protection against such interference when the equipment is operated in a commercial environment. Operation of this equipment in a residential area is likely to cause interference. In which case the user at their own expense will be required to take whatever measures may be necessary to correct the interference.

This equipment is CE, FCC and CSA certified.



CSA Certified file # 246552
(Complies with UL 60950-1, Second Edition U.S. Standards)



**Product Designed and Tested to Support Microsoft Windows
2000/XP/Vista/7**

Table of Contents

- 1. General 5
 - 1.1 Catx Cable Requirements 6
 - 1.2 RJ45 Port Functions 6
 - 1.3 User I/O Connector Descriptions 6
 - 1.4 Features 8
- 2. Installation 9
 - 2.1 Connecting the Sender to the PC 9
 - 2.2 Connecting the Sender local outputs 10
 - 2.3 Connecting the Sender to the Receiver 10
 - 2.4 Connecting the Receiver outputs 10
- 3. Configuration & Operation 11
 - 3.1 Sender Front Panel Controls and indicators 11
 - 3.2 Receiver Front Panel Controls and indicators 11
 - 3.3 Adjusting the Video to compensate for long UTP cables 12
- 4. Receiver Cover 14
- 5. Troubleshooting 16
- 6. Specifications 18

CAUTION:
PRODUCT CONTAINS HAZARDOUS VOLTAGES
NO USER SERVICEABLE PARTS INSIDE.

ATTENTION:
TENSION DANGEREUSE, L'APPAREIL NE COMPORTE AUCUN
ÉLÉMENT QUE L'UTILISATEUR PUISSE RÉPARER



1. General

U97-ULTRA-2B kit is used to extend Dual Display PC Video, Audio (both amplified or line-level), RS-232, and 3 independent USB ports to a remote location up to 150 m (500 feet) away on any Category Cable (CAT5e/6 UTP or STP).

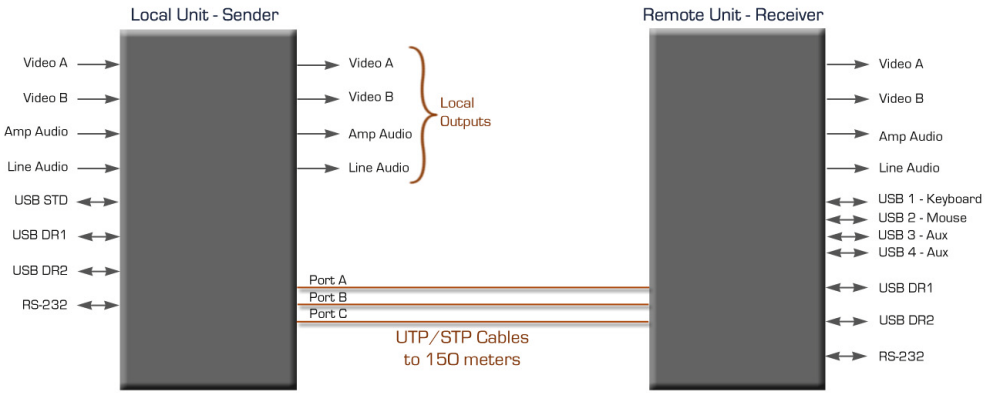

Block Diagram



1.1 Catx Cable Requirements

The connection between Sender (local) and Receiver (remote) unit requires 3 Category cables. Though Cat5e cables can be used, for best results, it is recommended to use CAT6 (UTP or STP) particularly for distances beyond 300 ft. Zero or low-skew cables are not needed since the device incorporates skew correction on both video channels.

1.2 RJ45 Port Functions

The RJ45 connectors on each unit are labeled Port A – Port C. The functions carried via each port is listed below. This chart is useful for trouble shooting purposes.

Port	Signals Extended	Comments
A	Video A, Audio, Video Calibration	Required in all applications
B	Video B, RS-232	May be omitted if Video B and RS-232 extension is not needed.
C	3 USB Ports	Required in all applications

1.3 User I/O Connector Descriptions

The Sender provides connectors for connection to the PC source and features local outputs at of both video ports and audio signals.



- ❑ VGA A & VGA B – These are PC’s video input and corresponding loop-output signals. They are extended to a remote unit through RJ45 Port A and Port B. High Frequency (HF) and RGB skew compensation is incorporated at the receiver to provide a brilliant image even at resolutions to 2560x1440.
- ❑ Audio – Two types of audio inputs are provided. Use only one of them
 - 3.5mm Mini-Stereo connector : This is from PC’s standard line output. The sender has a corresponding loop output, and the remote receiver also has a 3.5mm audio output jack

- DB15 connector (with 2 rows of pins) for amplified audio input and loop output. If your source can drive speakers directly, you can use this connector to tie to the source. You still have a loop output which is directly wired to the input pins on the Ultra Sender, so a local speaker can still be plugged in. The audio is extended to a remote receiver which features a similar powered output on a DB15
- USB STD – This is a general-purpose USB Port, which is extended to the remote receiver that features a built-in hub providing the user with 4 USB ports. These USB ports are labeled as KBRD 1, MOUSE 2, AUX 3, and AUX 4. These general-purpose USB ports support any type of low-speed or high-speed USB devices. AUX 3 and AUX 4 are typically used for touch screen displays, but support all other USB devices as well.
- DR1 & DR2 – These are two “Direct” extension USB ports. The corresponding USB port on the PC is directly extended to a remote receiver with no hubs or other functions in the path. The PC’s USB port that is extended via DR1 or DR2 behaves exactly as if it were connected directly to the target device at the remote. These “Direct” USB port extensions are perfect for high data rate devices, such as video cameras, printers and strip chart recorders.
- Serial RS-232 – Bi-directional extension of RS-232 data.

Both the sender and the receiver have built-in power supplies with standard IEC320 jacks (no external power bricks needed). The sender includes 6 ft cables for connection to the PC (3x USB, 2x VGA). The sender also includes rack-mount front panel.

The receiver includes a metal guard that covers all the connections, thereby eliminating the need for a separate utility box.

1.4 Features

- Combines the functions of Hall Research Models U97-H2, UU2X4-P1, two SKU-RGB, DVC-3 video test pattern generator, and more
- Eliminates the need for Utility Box (Receiver includes a guard plate that goes over all the connectors with tie-down provisions for strain relief)
- Does not require external power supply (built-in supply with standard 110~240 VAC IEC320 jack)
- Includes 2 "Direct" USB ports (DR1 & DR2), and a Standard with Hub at both ends.
- DB15 connector for Amplified audio input and loop output at the sender as well as DB15 output at the receiver to directly drive passive speakers
- Built-in video Skew Correction on both video channels. This corrects the lack of RGB convergence when long Cat6 cables are used. Eliminates the need to use special low-skew UTP cables for long runs.
- Built-in Test pattern generator for long cable compensation (High Frequency Gain) and Skew correction.
- Supports DDC channel with EDID (Extended display ID)

2. Installation

2.1 Connecting the Sender to the PC

Using the supplied cables; connect the sender to the PC.



Close-up of Sender Input Connections



Close-up of Sender UTP Connections

Connect PC's VGA outputs to VGA A IN and VGA B IN connectors using the supplied cables.

Connect the audio source to AUDIO connector using either the DB15 connector for amplified audio, or 3.5mm for line-level audio. To connect to the amplified audio a DB15 male-to-female cable is needed (not provided). Do not simultaneously connect both Audio inputs.

DB15 Pin	Function	Notes
12 & 13	Amplified audio input.	These pins are tied together, max input 10 Vp-p
4 & 5	Audio Return	These pins are tied together

If a serial communication is needed, connect a PC's serial port to RS232, a DB9 female connector. Usually a straight-thru DB9 M/F cable is required (not supplied).

Use the included USB cables to connect the PC to USB STD and DRx connectors. These are Type 'B' connectors, which are used to attach the USB cable to a USB device.

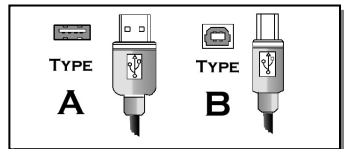

USB Port & Connector Types

2.2 Connecting the Sender local outputs

The sender has buffered outputs for connection of two LCD's, plus direct loop-thru of the DB15 and 3.5 mm audio inputs.



Close-up of Sender Local Outputs

2.3 Connecting the Sender to the Receiver

You typically need 3 UTP or STP cables to connect to sender to the receiver. See Section 1.1 and 1.2 for further details.

2.4 Connecting the Receiver outputs

The receiver outputs are shown below.



Receiver Rear Panel

Connect display devices such as two LCD's to the VIDEO 'A' & VIDEO 'B' connectors of the receiver.

Connect a LINE AUDIO OUT from the receiver to any standard PC external speakers (powered) using male to male 3.5mm audio patch cable.

If an amplified audio output level is desired, connect the receiver's PWR AUDIO OUT connector to the desired passive speaker. The volume of output is the same as that of the input at the sender.

Regardless of which input is connected at the Sender, both audio outputs on the Receiver are simultaneously active. For example you can hookup 3.5mm input to the Sender and a Passive speaker to the db15 connector of the Receiver.

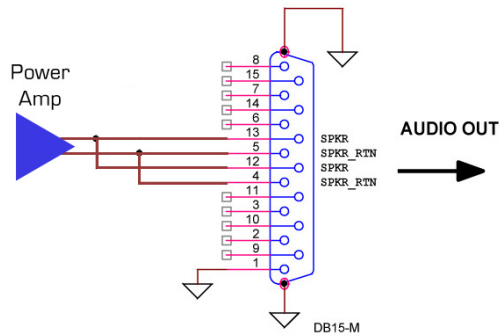

Receiver Audio Output Connector, DB15 – Female

If a serial communication is needed, connect a PC’s serial port to RS232, a DB9 male connector. The Serial port supports all baud rates to 115 K bps

3. Configuration & Operation

3.1 Sender Front Panel Controls and indicators

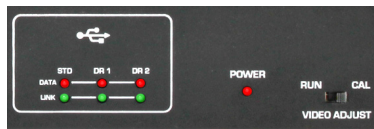

Keep the **VIDEO ADJUST** switch in RUN mode for normal operation. Set it to CAL (calibrate) mode to adjust the video at the remote unit per the following descriptions

3.2 Receiver Front Panel Controls and indicators

The Console Extender-Remote unit can be operated in two different modes, which are RUN -mode and CAL-mode.



In RUN-mode, all LEDs and buttons for video adjust are off. And tapping on the control buttons have no effect. This prevents accidental and unintended video adjustment, though it is possible to make adjustments in RUN mode by long pressing the Select button as described below.

In CAL-mode, the Sender disconnects the user's video input and substitutes an internally generated test pattern. The Receiver automatically recognizes the CAL mode and lights the video adjust LEDs

Lit LED	Mode
A	Calibrating Video A (Select, Up, and Down buttons adjust Video A output)
B	Calibrating Video B (Select, Up, and Down buttons adjust Video B output)
RED	Up and Down buttons adjust the horizontal position of Red components
GRN	Up and Down buttons adjust the horizontal position of Green components
BLU	Up and Down buttons adjust the horizontal position of Blue components
R+G+B	When all 3 LED's are lit the Up and Down buttons adjust the high-frequency gain of all video components

Notes:

- 1) Press and hold the UP or Down buttons to ramp through the adjustment
- 2) When you reach the max or min limit of any adjustment all 3 LEDs flash
- 3) To quickly jump to minimum setting press both UP and Down buttons together

3.3 Adjusting the Video to compensate for long UTP cables

There are two ways to get into the calibrate-mode to adjust the video:

- The first and recommended method is to use the VIDEO ADJUST switch on the Sender and set it to CAL. This puts the Receiver in the calibrate mode and also activates a test pattern. The Receiver stays in this calibrate-mode until the VIDEO ADJUST switch is set back to RUN.
- The other way to enter the calibrate-mode is to hold down the SELECT button for 3 seconds at the receiver, in this case the test pattern will not be displayed so the video output is the same as that connected at the Sender. If there is no user activity on the front panel for 1 minute, the receiver will time out and switch back to the run-mode.

The following figures show how an image can be adjusted to become perfect by using the receiver front panel controls.

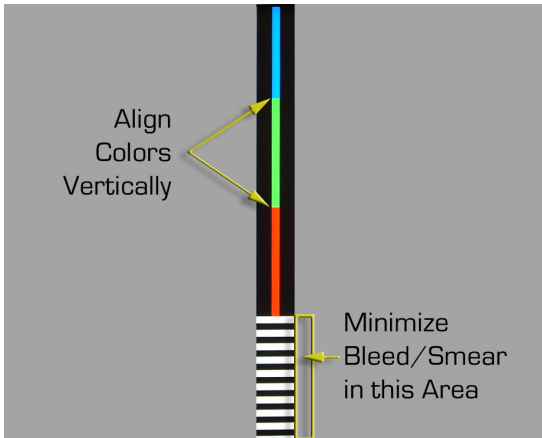

Test Pattern for HF Gain and Skew adjustments

Select the video channel that you are going to adjust (A or B).

Start by adjusting HF gain (hit Select button as needed to light all 3 LED's on the Receiver). It is best to start at the min compensation setting. To do this either press the Down button repeatedly until the LED's blink (indicates you are at min), or simply press both Up and Down buttons simultaneously.

If the UTP cable is long then the black and white horizontal lines tend to appear smeared (black smears as black, and white as white). Press the Up button one click at a time paying particular attention just to the right of the horizontal lines. Your goal is to make the transition between the horizontal black and white lines and the grey background to have as little smear as possible. Do not over adjust. If you do, some smear comes back particularly near the transition but in reverse sense (white lines smear as black and vice versa). The following images depict the adjustment results as seen on the screen:

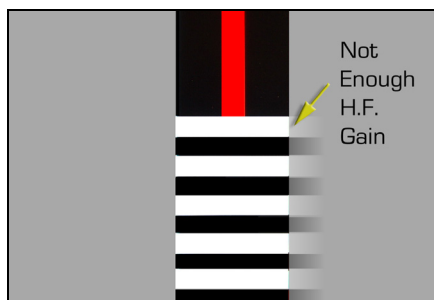

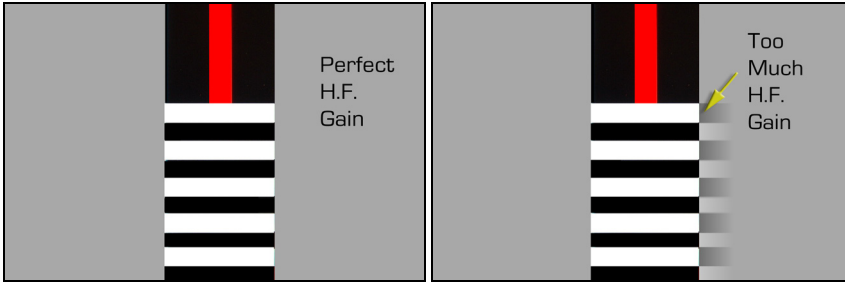

HF gain adjustment (zoomed view)

Once you have adjusted the HF Gain, hit the select button to cycle through the Red, Green and Blue colors and use the Up and Down buttons to align the colors vertically.

When you are all done, if you had initiated the calibration by using the Calibration switch on the sender, you should go back to the Sender and put the switch in the RUN mode. The Receiver's Calibration LED's will go out and the buttons will not be operative.

4. Receiver Cover

To prevent connectors from accidentally getting unplugged, the unit ships with a convenient cover that can snap onto the Receiver and cover-up all connections. In the diagram below the location of holes where the cover screws to the receiver are shown. All screws are provided with the unit. There are 4 screws on the top and 2 on the bottom (not shown).

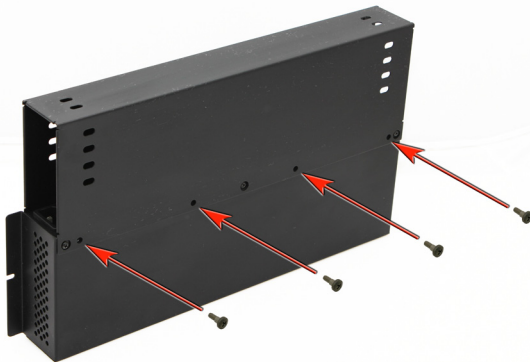

Locations of attachment holes for screws



Cables can enter and leave from either end

You can use the slotted holes at either end of the unit to zip-tie the cables in place.

Once the cover is firmly attached and cables zip-tied in place, you can screw the entire assembly to a suitable base using the L flanges on either side of the unit.

Make sure that the front panel is accessible for skew and or video adjustments as needed.

5. Troubleshooting

If the problem is related to the video clarity, check the calibration by placing the unit in CAL mode using the switch on the Sender and follow the steps in Section 2.5.

If the image on the remote display is not centered properly (e.g. there is a dark vertical stripe along left edge), use the LCD's on screen display to do an "Auto Adjust" Image – but do this **not** while the CAL mode is on. You should do this with your specific PC's video. It is also best to perform "Auto Adjust" when you have an image that spans the entire screen to all edges, like Windows background, or open Notepad, maximize it, then do Auto Adjust.

If the RGB LED's on the Receiver are always on, check the RJ45 PORT A connection to the sender. The CAL switch info is transmitted on PORT A and you may have crossed PORT A or there is a bad CATx connection.

If the problem is with the USB devices, check the state of the LED's on the front panel of the each unit. These LED's pertain to USB LINK and USB DATA status.

The green LINK LED's should be on if the Sender and Receiver are properly connected on RJ45 Port C.

If PC USB ports are connected to the Sender, then the red DATA LED should be on STD port (since there is a Hub and PC is communicating with the Hub) even if there are no peripherals connected to USB ports 1-4 of the Receiver. On the other hand the, DATA LED's for the DR1 and DR2 will only be on if there is a USB device connected and properly communicating with the PC.

Make sure that all connections to the PC and peripheral equipment are solid. Reboot the PC if any of the connections were loose as this may have caused the PC to lock up.

Check that the RJ45 port connections between the two ends are not crossed, loose, or disconnected. Use the following to narrow your attention depending on device you are having trouble with:

Port A of the UTP carries VGA A, AUDIO signals, and CAL switch state
Port B of the UTP carries VGA B and RS232 signals
Port C of the UTP carries the all USB signals

If you cannot trouble shoot the setup, please note all pertinent symptoms and make a list of any other equipment used in the setup prior to contacting Hall Research.

CAUTION:

PRODUCT CONTAINS HAZARDOUS VOLTAGES
NO USER SERVICEABLE PARTS INSIDE.

ATTENTION:

TENSION DANGEREUSE, L'APPAREIL NE COMPORTE AUCUN
ÉLÉMENT QUE L'UTILISATEUR PUISSE RÉPARER



Do not open or try to repair the unit yourself. There is no customer repairable item in the unit and you will void the warranty.

Contact Hall Research Technical Support Department at 714-641-6607 or via email or web. If you need to ship your switch for repair, make sure to get a Return Material Authorization (RMA) number first.

6. Specifications

Video

Video Inputs	PC outputs (VGA to WQHD)
Resolutions	PC resolutions up to 2560x1440 @ 60 Hz
Video Levels	0 to 0.7v p-p

Dimensions

Sender	1.5" High x 19" Wide x 5.06" Deep
Receiver	1.75" High x 14" Wide x 4.06" Deep

Weight

Sender	4 lbs
Receiver	3 lbs

Power

Input Voltage.	100VAC – 240VAC 50/60Hz
Sender Consumption	5 watts max.
Receiver Consumption	8 watts max.

Others

USB Support	Low Speed devices (1.5Mb/s) Full Speed devices (12Mb/s) High Speed devices on DR1 and DR2 only (480Mb/s)
UTP Cable	Up to 100m (330 ft) using Cat5e or 150m (500 ft) using Cat6
Temperature	Operating: 32 to 122°F (0 to 50°C); Storage: -40 to +185°F (-40 to +85°F)
Enclosure	Steel
MTBF	90,000 hours (calculated estimate)



© Copyright 2016. Hall Research, Inc.
All rights reserved.

1163 Warner Ave., Tustin, CA 92780
Ph: (714)641-6607, Fax: (714)641-6698