

Features

- 12.1" New Generation Stainless Steel Panel PC
- Intel Celeron J6412 2.0GHz Onboard Processor
- True Flat Front Bezel Design and Grade 304 Stainless Steel Enclosure (Grade 316 for option)
- IP66/IP69K Rated with M12 Connectors
- Support Resistive Touch and Projected Capacitive Touch
- Touch on/off Button on the Side Edge for Hygienic Cleaning
- Support Ergonomic Versatile Mounting: Yoke Mounting / Space-saving VESA 75 x 75 mm Mounting

Specifications

System	
CPU	Onboard Intel Celeron J6412(2.0 GHz) Processor
System Chipset	SoC
Memory	1 x 260-pin SO-DIMM up to 32GB DDR4 3200MHz
TPM	TPM 2.0
IO Port	
USB	1 x M12 8-pin for USB 2.0 with waterproof cover
Serial / Parallel	1 x M12 8-pin COM1, RS-232/422/485, default RS-232, with waterproof cover
LAN	1 x M12 8-pin for LAN with waterproof cover
Others	1 x Touch on/off button at the side
Power Connector	1 x M12 3-pin for DC power with waterproof cover 1 x Power switch on the rear
Option	2 x optional blank M12 connector with waterproof cover for selecting two from the following options: 2 x USB 2.0 1 x USB 3.0 1 x LAN 1 x COM

Storage Space	
HDD	1 x 2.5" SATA3 HDD
M.2	1 x M.2 B-Key(SATA 3), Support 2242 at default

Expansion	
Expansion slot	1 x Mini-PCIe slot for 4G/5G module 1 x M.2 E-Key 2230 for WiFi/BT module 1 x Nano SIM slot
RFID module	RFID Module Design on the Front Side (for option)

Display	Standard		High Brightness Optional	
	12.1" TFT-LCD		12.1" TFT-LCD	
Display Type	default	optional	default	optional
Max. Resolution	800 x 600	1024 x 768	800 x 600	1024 x 768
Max. Color	16.7M	16.2M	16.7M	16.2M
Luminance (cd/m ²)	450	500	1000	1000
View Angle	176(H)/176(V)	178(H)/178(V)	176(H)/176(V)	178(H)/178(V)
Contrast	1000:1	1000:1	1000:1	1000:1
Backlight Lifetime	50,000 hrs	30,000 hrs	50,000 hrs	70,000 hrs

Touch Screen	
Type	Resistive Touch (For BR model) Projected Capacitive Touch (For BP model)
Interface	USB
Light Transmission(%)	Resistive Touch : 80% / Projected Capacitive : 90%

Dimensions

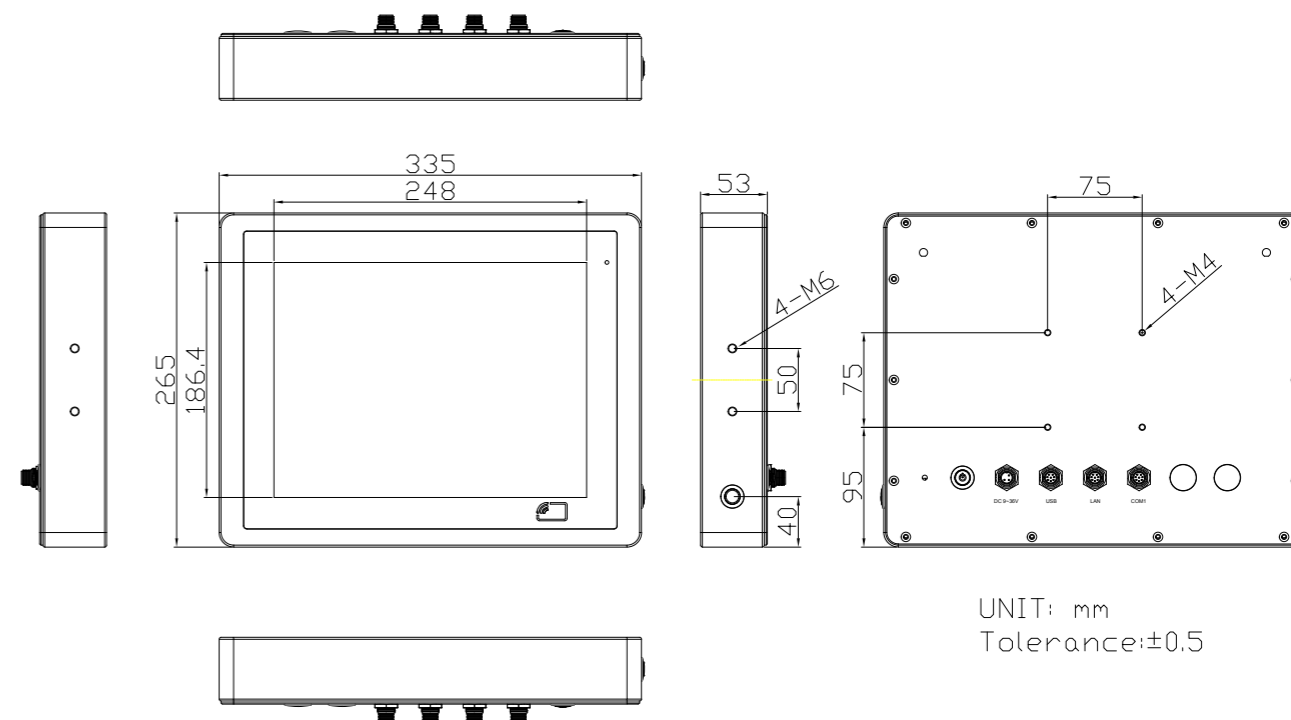

UNIT: mm
Tolerance:±0.5

Power	
Power Input	DC 9~36V
Power Consumption	ViTAM-812BP: 34.14W (MAX)

Mechanical	
Construction	304 Stainless steel chassis(default), 316 Stainless steel chassis(optional)
Mounting	VESA mount 75 x 75, Yoke mount for optional
IP Rating	Total IP66/IP69K
Dimensions	335 x 265 x 53 mm
Net Weight	4.83 kg

Environmental	
Operating Temperature	0~50°C / -20~60°C (option)
Storage Temperature	-30~70°C
Humidity	10 to 95% @ 40°C, non-condensing
Certificate	CE/FCC Class A

Operating System Support	
Windows 10, Windows 11	